

A.N.A AMITY IMPEX

A.N.A Square, Airport Road Muradpur, Sialkot-51360, Pakistan.

Tel: +92-52-4268654

E-mai: info@anaamity.com

Tel: +92-52-4564127

anaamityimpex@gmail.com

Fax: +92-52-4261027

sales@anaamity.com

Cell: +92-300-8618654

Web : www.anaamity.com

VAGINAL SPECULA



Vaginalspekula
Especulos vaginales

Spéculums vaginaux
Specoli vaginali



GRAVES
ANA-019-100
75 x 20 mm Small
ANA-019-101
95 x 35 mm Medium
ANA-019-102
115 x 35 mm Large



PEDERSON
ANA-019-103
75 x 13 mm Small
ANA-019-104
100 x 22 mm Medium
ANA-019-105
120 x 25 mm Large



**Graves Vaginal
Speculum Leep / Lietz**
ANA-019-106 Small
ANA-019-107 Medium
ANA-019-108 Large
ANA-019-109 X-large



**Pederson Vaginal
Speculum Leep / Lietz**
ANA-019-110 Small
ANA-019-111 Medium
ANA-019-112 Large
ANA-019-113 X-large

VAGINAL SPECULA



Vaginalspekula
Especulos vaginales

Spéculums vaginaux
Specoli vaginali



DE VILBISS
ANA-019-114
4 x 27 mm
102 mm x 32 mm
Medium



SEYFFERT
ANA-019-115 100 x 24 mm
ANA-019-116 110 x 32 mm
23 cm, 9"



CUSCO
ANA-019-117 75 x 32 mm
ANA-019-118 85 x 35 mm
ANA-019-119 100 x 35 mm



CUSCO
ANA-019-120 75 x 17 mm



CUSCO
ANA-019-121 90 x 22 mm
ANA-019-122 100 x 25 mm
ANA-019-123 105 x 27 mm

VAGINAL SPECULA



Vaginalspekula
Especulos vaginales

Spéculums vaginaux
Specoli vaginali



CUSCO
ANA-019-124 75 x 32 mm
ANA-019-125 85 x 35 mm
ANA-019-126 100 x 37 mm



COLLIN
ANA-019-127 85 x 30 mm
ANA-019-128 100 x 35 mm
ANA-019-129 110 x 40 mm



SEMM
ANA-019-130 100 x 17 / 20 mm
ANA-019-131 105 x 27 / 30 mm

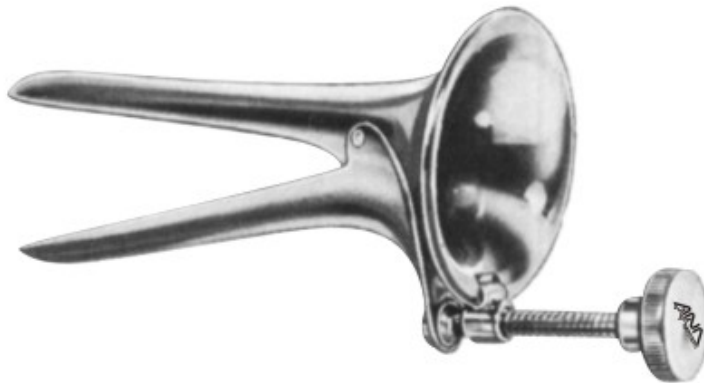

COLLIN
ANA-019-132
 55 x 10 mm



TRELAT
ANA-019-133 85 mm 33 mm
ANA-019-134 95 mm 35 mm
ANA-019-135 115 mm 43 mm



WINTERTON
ANA-019-136



NOTT
ANA-019-137 90 mm 30 mm
ANA-019-138 100 mm 30 mm

VAGINAL SPECULA-SETS



Vaginalspekula
Especulos vaginales

Spéculum vaginaux
Specoli vaginali



ANA-019-145
75x10 mm
17.5 cm

ANA-019-146
75x23 mm
18.0 cm

ANA-019-147
80x25 mm
18.0 cm

ANA-019-148
100x32 mm
18.5 cm

ANA-019-150
70x15 mm
175 mm

ANA-019-151
70x27 mm
18.0 cm

ANA-019-152
75x30 mm
18.0 cm

ANA-019-153
90x36 mm
18.5 cm

KRISTELLER
ANA-019-139 110x18 mm
ANA-019-140 110x20 mm
ANA-019-141 110x27 mm
ANA-019-142 110x30 mm
ANA-019-143 110x36 mm
22.0 cm,

KRISTELLER
ANA-019-144
Upper Blades

KRISTELLER
ANA-019-149
Lower Blades

VAGINAL SPECULA (UPPER AND LOWER BLADES)



Vaginalspekula
Espéculos vaginales

Spéculums vaginaux
Specoli vaginali



ANA-019-155

115x14 mm
21.5 cm

ANA-019-156

115x16 mm
21.5 cm

ANA-019-157

115x23 mm
21.5 cm

ANA-019-158

115x26 mm
21.5 cm

ANA-019-159

115x26 mm
22.5 cm

KRISTELLER
ANA-019-154
Upper Blades

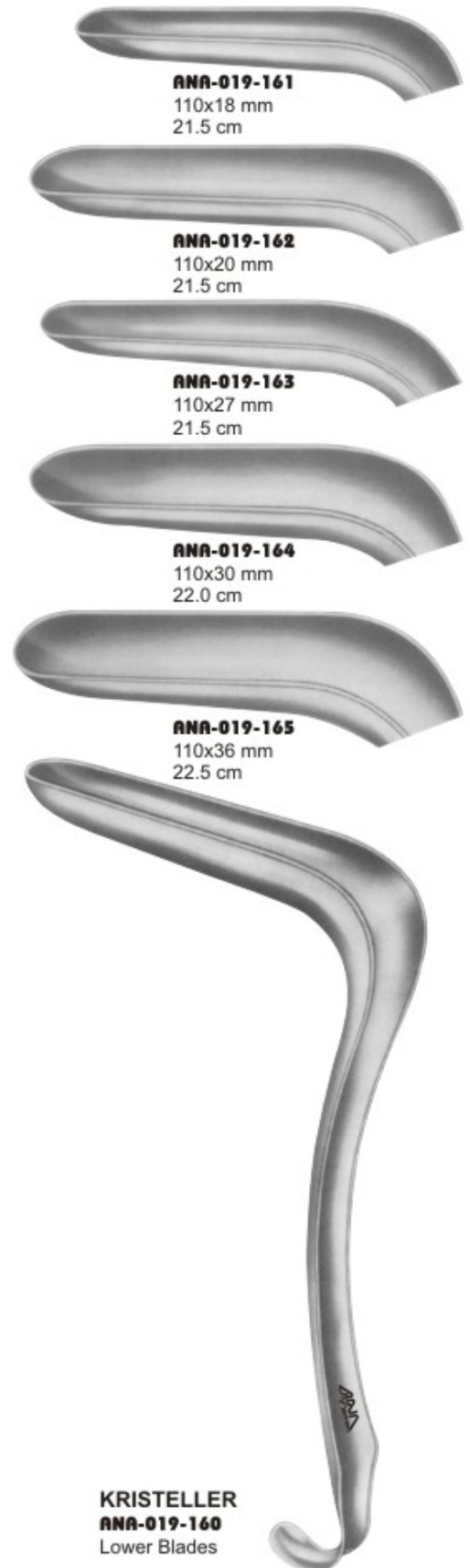

ANA-019-161

110x18 mm
21.5 cm

ANA-019-162

110x20 mm
21.5 cm

ANA-019-163

110x27 mm
21.5 cm

ANA-019-164

110x30 mm
22.0 cm

ANA-019-165

110x36 mm
22.5 cm

KRISTELLER
ANA-019-160
Lower Blades

VAGINAL SPECULA



Vaginalspekula
Espéculos vaginales

Spéculums vaginaux
Specoli vaginali



ANA-019-167
80 x 28 mm



ANA-019-171
76 x 38 mm



ANA-019-168
85 x 35 mm



ANA-019-172
89 x 38 mm



ANA-019-169
85 x 40 mm



ANA-019-173
102 x 38 mm

Slightly Concave



KRISTELLER
ANA-019-166
20.5 cm, 8"

Slightly Concave



JACKSON
ANA-019-170
17.5 cm, 7"

VAGINAL SPECULUM



Vaginalspekula
Especulos vaginales

Spéculum vaginaux
Specoli vaginali



56 x 13 mm

BRAUN
ANA-019-174
18 cm, 7"



60 x 10 mm

BRAUN
ANA-019-175
18 cm, 7"



ANA-019-176
Handle with cold light
carrier for upper blades
28 cm, 11"



SIMON
ANA-019-177
115 x 22 mm
27.5 cm, 10 3/4"



95 x 17-26 mm

MATHIEU
ANA-019-178
For children and
virgins fitting
21 cm, 8 1/2"



95 x 17 - 30 mm

MATHIEU
ANA-019-179
For children
and virgins
21 cm, 8 1/2"

VAGINAL SPECULA, VAGINAL RETRACTORS



Vaginalspekula, scheidenhalter
Especulos vaginales, valvas vaginales

Spéculums vaginaux, valves vaginales
Specoli vaginali, valve vaginali



BRIESKY
ANA-019-180 72x25 mm / 77x30 mm
ANA-019-181 75x30 mm / 92x38 mm
17 cm, 6 3/4"

KALLMORGEN VAGINAL SPECULUM
ANA-019-182 70 x 40 mm
ANA-019-183 90 x 40 mm
20 cm, 8"

KALLMORGEN VAGINAL RETRACTOR
ANA-019-184 70 x 33 mm
ANA-019-185 90 x 33 mm
20 cm, 8"

MATHIEU Vaginal Retractor
ANA-019-186 95 x 16 mm
ANA-019-187 95 x 26 mm
ANA-019-188 95 x 30 mm
21 cm, 8 1/2"

MATHIEU Vaginal Retractor
ANA-019-189 100 x 11 mm
ANA-019-190 100 x 14 mm
ANA-019-191 100 x 20 mm
ANA-019-192 100 x 26 mm
22 cm, 8 3/4"



DOYEN VAGINAL SPECULUM
22 cm, 8 3/4"



ANA-019-193 60 x 35 mm
ANA-019-194 90 x 35 mm
ANA-019-195 120 x 35 mm
ANA-019-196 60 x 45 mm
ANA-019-197 90 x 45 mm
ANA-019-198 120 x 45 mm
ANA-019-199 160 x 45 mm
ANA-019-200 60 x 60 mm
ANA-019-201 90 x 60 mm
ANA-019-202 120 x 60 mm
ANA-019-203 160 x 60 mm



LANDON VAGINAL RETRACTOR
ANA-019-204
Blade 9 cm
Deep 2.5 cm wide.

VAGINAL SPECULA (FOR CHILDREN AND VIRGINS)



Vaginalspekula
Especulos vaginales

Spéculum vaginaux
Specoli vaginali



DOYEN
ANA-019-205
23.5 cm, 9 1/4"

ANA-019-206
60 x 45 mm



ANA-019-207
90 x 45 mm



ANA-019-208
112 x 45 mm

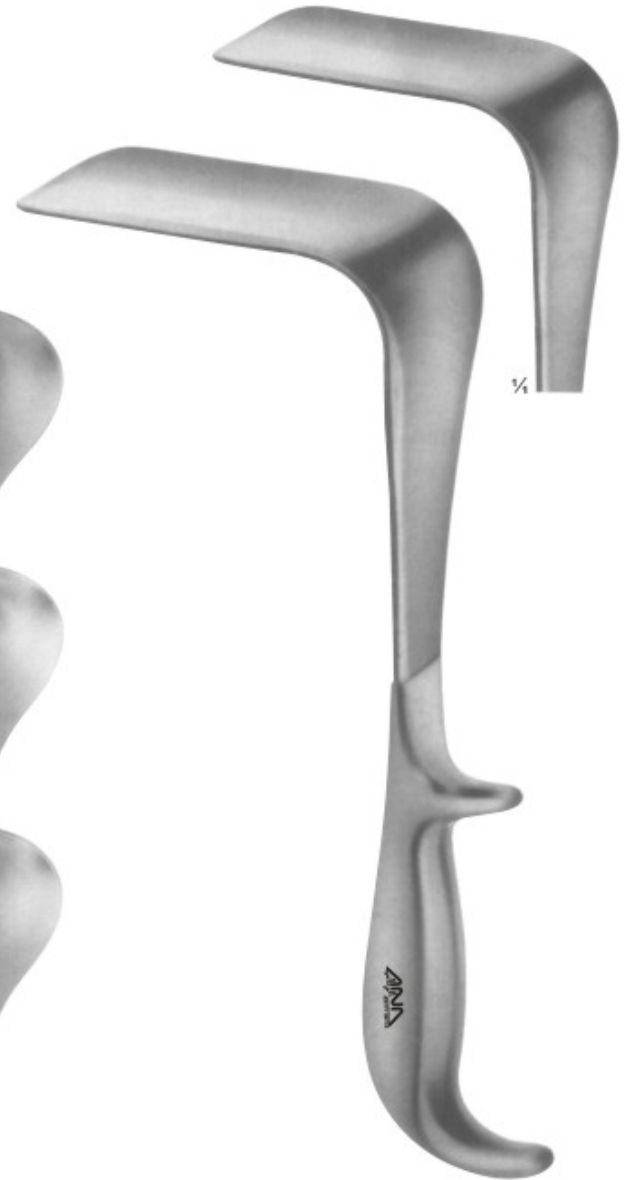

	Length of blades	Width of blades
ANA-019-209	60 mm	35 mm
ANA-019-210	90 mm	45 mm
ANA-019-211	120 mm	60 mm
ANA-019-212	160 mm	70 mm
	19 cm, 7 1/2"	

VAGINAL SPECULA & RETRACTORS



Vaginalspekula, scheidenhalter
Especulos vaginales, valvas vaginales

Spéculums vaginaux, valves vaginales
Specoli vaginali, valve vaginali



BREISKY
**WIENER MODELL/
VIENNA PATTERN**
ANA-019-213 100 x 20 mm
ANA-019-214 100 x 25 mm
ANA-019-215 100 x 30 mm
ANA-019-216 100 x 35 mm
ANA-019-217 100 x 40 mm
30 cm, 12"



BREISKY
**WIENER MODELL/
VIENNA PATTERN**
ANA-019-218 130 x 20 mm
ANA-019-219 130 x 25 mm
ANA-019-220 130 x 30 mm
ANA-019-221 130 x 35 mm
ANA-019-222 130 x 40 mm
32 cm, 12 1/2"



LANDAU
ANA-019-223 105 x 28 mm
ANA-019-224 105 x 38 mm
30 cm, 12"



WEISSBARTH
ANA-019-225 80 x 28 mm
ANA-019-226 85 x 42 mm
21 cm, 8 1/4"



DOYEN
Lateral Speculum
ANA-019-227 80 x 30 mm
25 cm, 10"

VAGINAL SPECULUM



Vaginalspekula
Especulos vaginales

Spéculum vaginaux
Specoli vaginali



AUVARD
ANA-019-228
65 x 38 mm - 28 mm
1,530 kg
with fixed weight
23 cm, 9"



AUVARD
ANA-019-229 75 x 42 mm
(40 mm)
ANA-019-230 105 x 43 mm
(40 mm)
with detachable weight
23 cm, 9"



MARTIN
ANA-019-231
with hook shaped
handle for hanging
in weights
27 cm, 10 3/4"

VAGINAL SPECULUM



Vaginalspekula
Espéculos vaginales

Spéculums vaginaux
Specoli vaginali



ANA-019-232
80 x 30



ANA-019-235
55 x 40 - 60 mm



ANA-019-233
85 x 35



ANA-019-236
70 x 45 - 70 mm



ANA-019-234
85 x 40



ANA-019-238
80 x 30 mm



ANA-019-242
65 x 30 mm



ANA-019-239
85 x 33 mm



ANA-019-243
75 x 35 mm



ANA-019-240
100 x 38 mm



ANA-019-244
85 x 35 mm

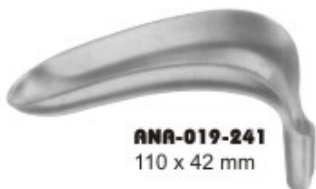

ANA-019-241
110 x 42 mm



ANA-019-245
95 x 35 mm



SCHERBACK
ANA-019-237
Set consisting of:
handle
weight
5 blades



SCHERBACK
ANA-019-246
Set consisting of:
2 handle
8 blades

UTERIN SOUNDS, VAGINAL SPECULUM



*Uterussonden, Vaginalspekula
histerómetros, Espéculos vaginales,*

*Hystérometres, Spéculums vaginaux,
isterometri, Specoli vaginali,*

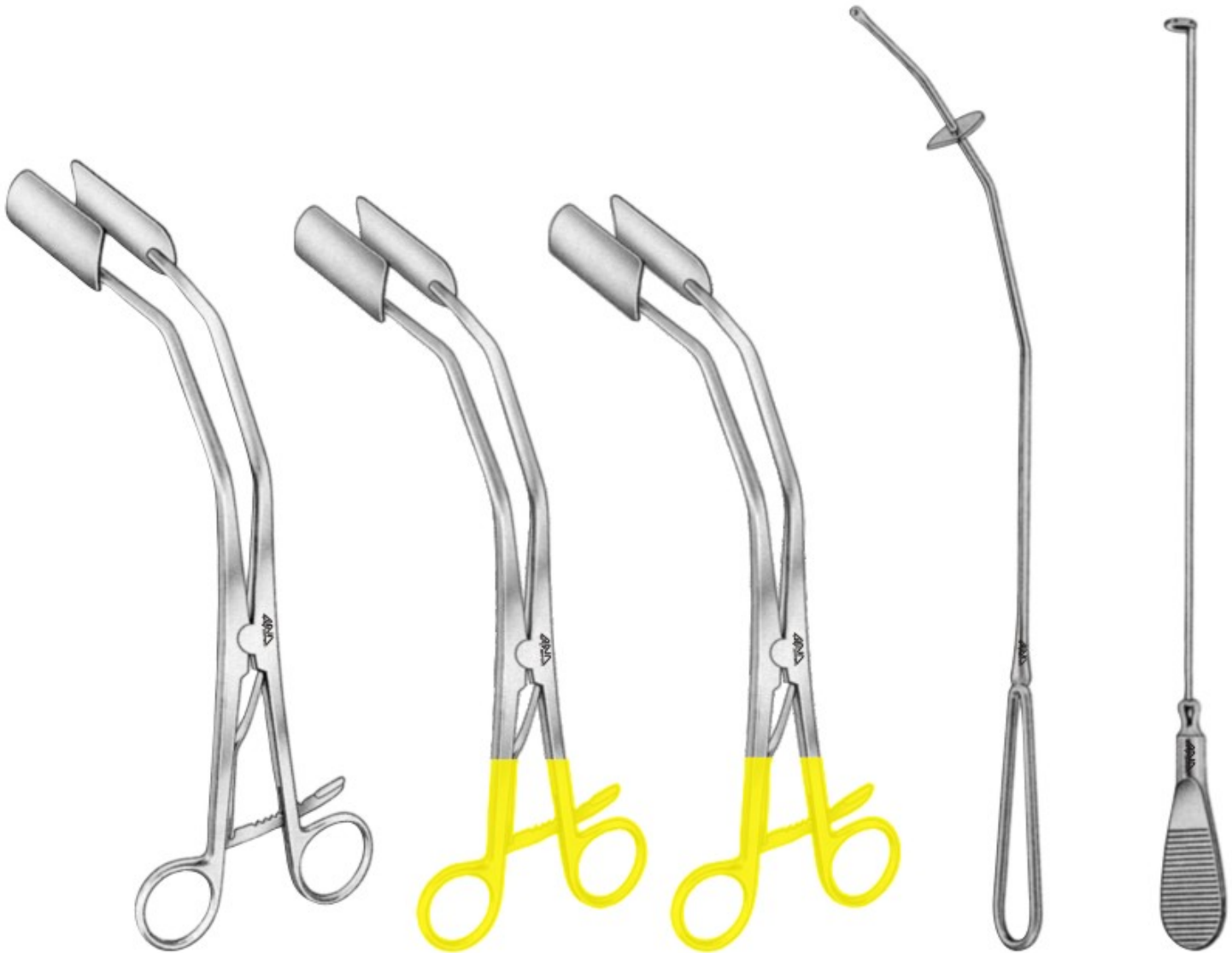

NEW PORT
ANA-019-247
25 cm, 10"

Lateral Vaginal Retractor
ANA-019-248
21 cm 8 1/4"

Lateral Vaginal Retractor
Blue Coated Leep / Lietz
ANA-019-249
21 cm 8 1/4"

RAMATHIBODI
ANA-019-250
27.5 cm, 11"
Uterine Manipulator

RAMATHIBODI
ANA-019-251
25 cm, 10"
Tubal hook

VAGINAL SPECULUM



Vaginalspekula
Espéculos vaginales

Spéculums vaginaux
Specoli vaginali

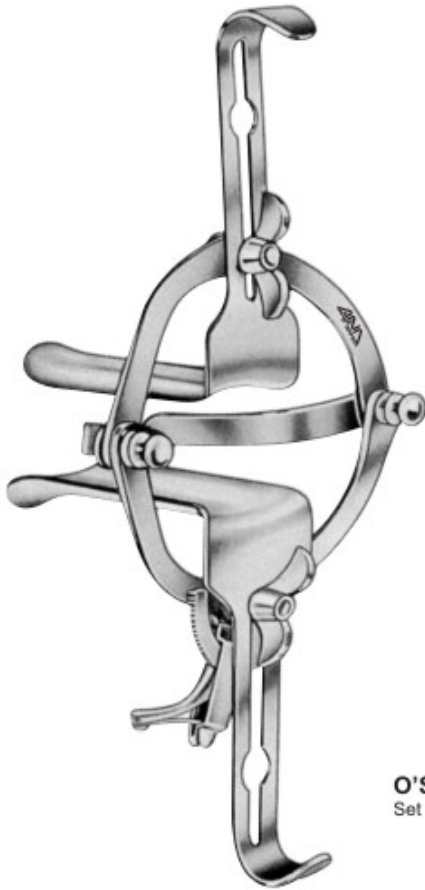

ANA-019-253
45 x 17 mm



ANA-019-254
90 x 37 mm



ANA-019-255
90 x 45 mm

O'SULLIVAN - O'CONNOR
Set of Complete
ANA-019-252
ANA-019-253
ANA-019-254
ANA-019-255



ABDOMINAL RETRACTOR
ANA-019-256 9 cm, 3 1/2" wide
ANA-019-257 10 cm, 4" wide
ANA-019-258 11.5 cm, 4 1/2" wide



FRIEDMANN
ANA-019-260
10 cm, 4"

UTERINE TENACULUM FORCEPS



Hakenzangen, amniotom
Pinza para cuello uterino, amniótomo

Pince pour le col de l'utérus, amniotome
Pinza per il collo dell'utero, amniotomo

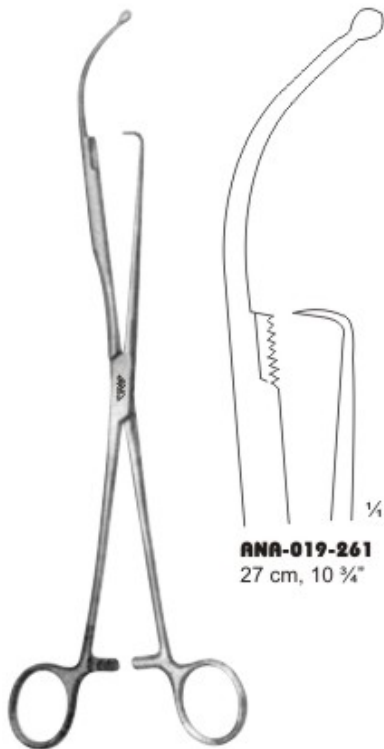

ANA-019-261
27 cm, 10 3/4"

HULKA GYNE



ANA-019-262
24 cm, 9 1/2"
With ratchet
3 mm

KOGAN GYNE



KOGAN
ANA-019-263
24 cm, 9 1/2"



KOGAN
ANA-019-264
24 cm, 9 1/2"

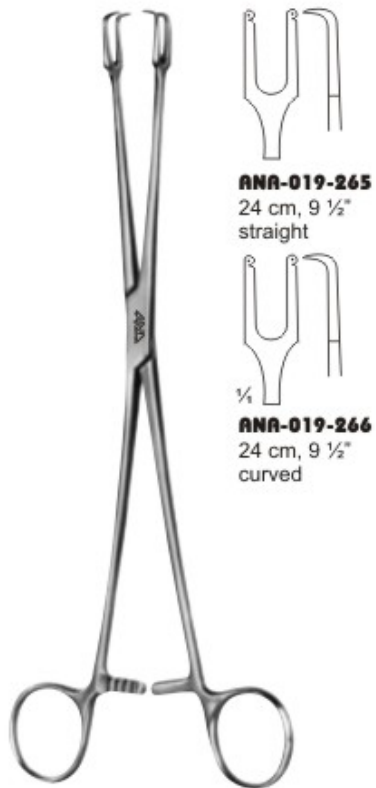

ANA-019-265
24 cm, 9 1/2"
straight

ANA-019-266
24 cm, 9 1/2"
curved

SCHRÖDER GYNE



ANA-019-267
25 cm, 10"

SCHRÖDER



ANA-019-268
25 cm, 10"

POZZI GYNE

UTERINE TENACULUM & UTERINE POLYPUS FORCEPS



Hakenzangen, Uterus-Polypen zangen

Pince pour le col de l'utérus, pinces a ploypes utérins

Pinza para cuello uterino, Pinzas para polipos uterinos

Pinza per il collo dell'utero, Pinze per polipi uterini



BARRETT
ANA-019-269
18 cm, 7"



SAIRGES
ANA-019-270
23 cm, 9"



MUSEUX
24 cm, 9 1/2"



ANA-019-271
6 mm



ANA-019-272
8 mm



ANA-019-273
10 mm



MUSEUX
24 cm, 9 1/2"



ANA-019-274
6 mm



ANA-019-275
8 mm



ANA-019-276
10 mm



PRATT
ANA-019-277
28 cm, 11"

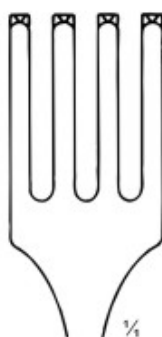

TEALE
ANA-019-278
23 cm, 9"



MYOMA SCREWS, MYOMA KNIFE, UTERINE SEIZING FORCEPS

Myomheber, Myommesser, Uterusfazzange

Tracteurs pour fibromes, evideur de fibromes, Pinces hystérolabes

Tirabuzones para fibroma, cuchillo para fibroma, Histerólabos

Tiramiomi, bisturi per fibromi, Pinze isterolabi



JACOBS
ANA-019-279
21 cm, 8 1/4"
Straight



IOWA
ANA-019-280
26 cm, 10 1/4"

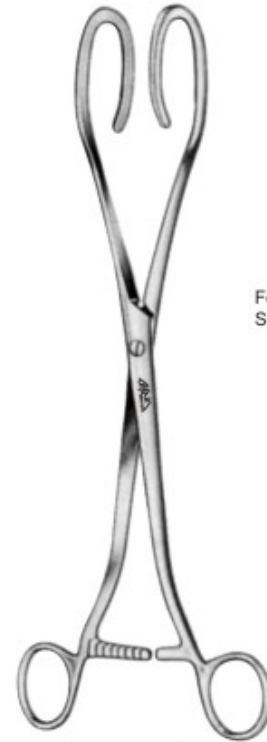

DARTIGUES
ANA-019-281
27 cm, 10 1/2"

For polypus forcepssee Section 6.



DOYEN
ANA-019-282
17 cm, 6 3/4"



DOYEN
ANA-019-283
14 cm, 5 1/2"

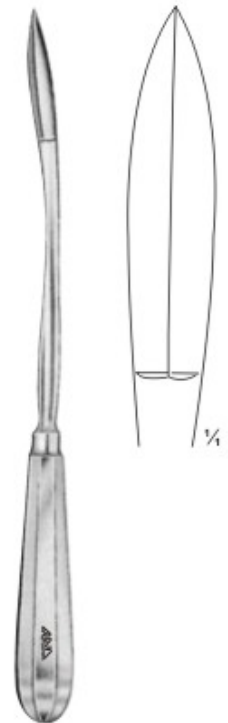

SEGOND
ANA-019-284
27 cm, 10 1/2"

UTERINE SCOOPS, SUCTION CURETTES & UTERINE DEPRESSOR

Uteruslöffel, Absaugküretten, uterusdepressor
Cucharillas uterinas, Curetas aspiradoras, depresor uterino

Curettes uterines, curettes d'aspiration, Dépresseur utérin
Curette uterine, curette pe aspirazione, depressore uterino



BRAUN
ANA-019-285
28 cm, 11"

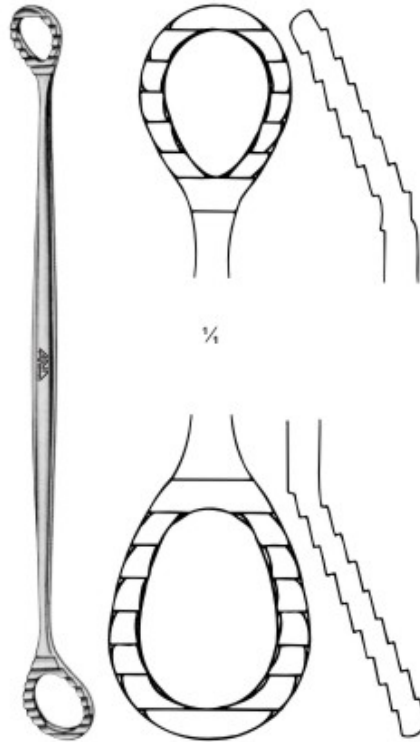

SIMS
ANA-019-286
26 cm, 10 1/4"

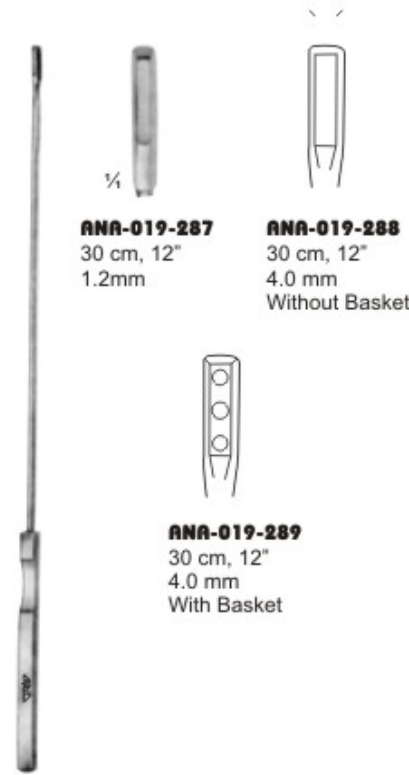

ANA-019-287
30 cm, 12"
1.2mm

ANA-019-288
30 cm, 12"
4.0 mm
Without Basket

ANA-019-289
30 cm, 12"
4.0 mm
With Basket

KEVORKIAN



BLAKE
ANA-019-290
27 cm, 10 3/4"



SCHROEDER
30 cm, 12"
sharp, rigid

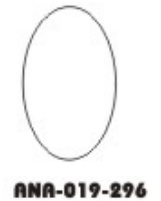
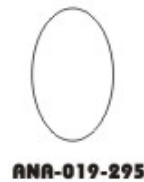

UTERINE SCOOPS, SUCTION CURETTES & UTERINE DEPRESSOR

Uteruslöffel, Absaugküretten, uterusdepressor
Cucharillas uterinas, Curetas aspiradoras, depresor uterino

Curettes uterines, curettes d'aspiration, Dépresseur utérin
Curette uterine, curette pe aspirazione, depressore uterino



**SIMON/
SCHRODER**



Fig. 1
ANA-019-297 25 cm, 10"
ANA-019-298 30 cm, 12"

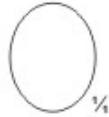

Fig. 3
ANA-019-301 25 cm, 10"
ANA-019-302 30 cm, 12"

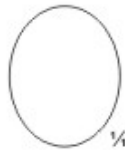

Fig. 5
ANA-019-305 25 cm, 10"
ANA-019-306 30 cm, 12"



Fig. 2
ANA-019-299 25 cm, 10"
ANA-019-300 30 cm, 12"



Fig. 4
ANA-019-303 25 cm, 10"
ANA-019-304 30 cm, 12"

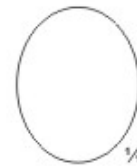

Fig. 6
ANA-019-307 25 cm, 10"
ANA-019-308 30 cm, 12"



COLLIN
28 cm, 11"



ANA-019-309
8.0 mm



ANA-019-310
10.0 mm



ANA-019-311
12.0 mm



ANA-019-312
14.0 mm



GOURDET
28 cm, 11"



Fig. 1
ANA-019-313



Fig. 2
ANA-019-314



Fig. 3
ANA-019-315



Fig. 4
ANA-019-316



Fig. 5
ANA-019-317

UTERINE CURETTES



Uterusküretten
Curetas uterinas

Curettes utérines
curette uterine



ANA-019-318
ANA-019-319
5mm



ANA-019-320
ANA-019-321
6mm



ANA-019-322
ANA-019-323
7mm



ANA-019-324
ANA-019-325
8mm



ANA-019-326
ANA-019-327
9mm



ANA-019-328
ANA-019-329
11mm



ANA-019-330
ANA-019-331
12mm



ANA-019-332
ANA-019-333
14mm



ANA-019-334
ANA-019-335
15mm



ANA-019-336
ANA-019-337
16mm



ANA-019-338
ANA-019-339
19mm



ANA-019-340
ANA-019-341
20mm



ANA-019-342
ANA-019-343
21mm



ANA-019-344
ANA-019-345
23mm



ANA-019-346
ANA-019-347
25mm



ANA-019-348
ANA-019-349
30mm



ANA-019-350
ANA-019-351
35mm



$\frac{1}{4}$
ANA-019-352
ANA-019-353
40mm

RECAMIER UTERINE CURETTE

ANA-019-318 26 cm 10 $\frac{1}{4}$ "

ANA-019-319 31cm, 12 $\frac{1}{4}$ "
Sharp/Blunt

UTERINE CURETTES

























Uterusküretten
Curetas uterinas

Curettes utérines
curette uterine



Recamier
Uterine Curette
ANA-019-354
26 cm, 10 1/4"
ANA-019-355
31cm, 12 1/2"
Sharp/Blunt

						
ANA-019-354 ANA-019-355 5mm	ANA-019-356 ANA-019-357 6mm	ANA-019-358 ANA-019-359 7mm	ANA-019-360 ANA-019-361 23-262-310 8mm	ANA-019-362 ANA-019-363 9mm	ANA-019-364 ANA-019-365 11mm	ANA-019-366 ANA-019-367 12mm
						
ANA-019-368 ANA-019-369 14mm	ANA-019-370 ANA-019-371 15mm	ANA-019-372 ANA-019-373 16mm	ANA-019-374 ANA-019-375 19mm	ANA-019-376 ANA-019-377 20mm	ANA-019-378 ANA-019-379 21mm	ANA-019-380 ANA-019-381 23mm
				ANA-019-382 ANA-019-383 25mm	ANA-019-384 ANA-019-385 30mm	ANA-019-386 ANA-019-387 35mm
				ANA-019-388 ANA-019-389 40mm	ANA-019-384 ANA-019-385 30mm	ANA-019-386 ANA-019-387 35mm

UTERINE CURETTES



*Uterusküretten
Curetas uterinas*

*Curettes utérines
curette uterine*



Sims
Uterine Curette
ANA-019-390
26 cm, 10 1/4"
ANA-019-391
31 cm, 12 1/2"
Sharp/Blunt



ANA-019-392
ANA-019-393
5mm



ANA-019-394
ANA-019-395
6mm



ANA-019-396
ANA-019-397
7mm



ANA-019-398
ANA-019-399
8mm



ANA-019-400
ANA-019-401
9mm



ANA-019-402
ANA-019-403
11mm



ANA-019-404
ANA-019-405
12mm



ANA-019-406
ANA-019-407
14mm



ANA-019-408
ANA-019-409
15mm



ANA-019-410
ANA-019-411
16mm



ANA-019-412
ANA-019-413
19mm



ANA-019-414
ANA-019-415
20mm



ANA-019-416
ANA-019-417
21mm



ANA-019-418
ANA-019-419
23mm



ANA-019-420
ANA-019-421
25mm



ANA-019-422
ANA-019-423
30mm



ANA-019-424
ANA-019-425
35mm



ANA-019-426
ANA-019-427
40mm

UTERINE CURETTES





















Uterusküretten
Curetas uterinas

Curettes utérines
curette uterine



Sims
Uterine Curette
ANA-019-428
26 cm, 10 1/4"
ANA-019-429
31cm, 12 1/2"
Sharp/Blunt

							
ANA-019-430 ANA-019-431 5mm	ANA-019-432 ANA-019-433 6mm	ANA-019-434 ANA-019-435 7mm	ANA-019-436 ANA-019-437 8mm	ANA-019-438 ANA-019-439 9mm	ANA-019-440 ANA-019-441 11mm	ANA-019-442 ANA-019-443 12mm	
							
ANA-019-444 ANA-019-445 14mm	ANA-019-446 ANA-019-447 15mm	ANA-019-448 ANA-019-449 16mm	ANA-019-450 ANA-019-451 19mm	ANA-019-452 ANA-019-453 20mm	ANA-019-454 ANA-019-455 21mm	ANA-019-456 ANA-019-457 23mm	ANA-019-458 ANA-019-459 25mm
							
ANA-019-460 ANA-019-461 30mm	ANA-019-462 ANA-019-463 35mm	ANA-019-464 ANA-019-465 40mm					

UTERINE SOUNDS



Uterussonden
Histerómetros

Hystérometres
Isterometri

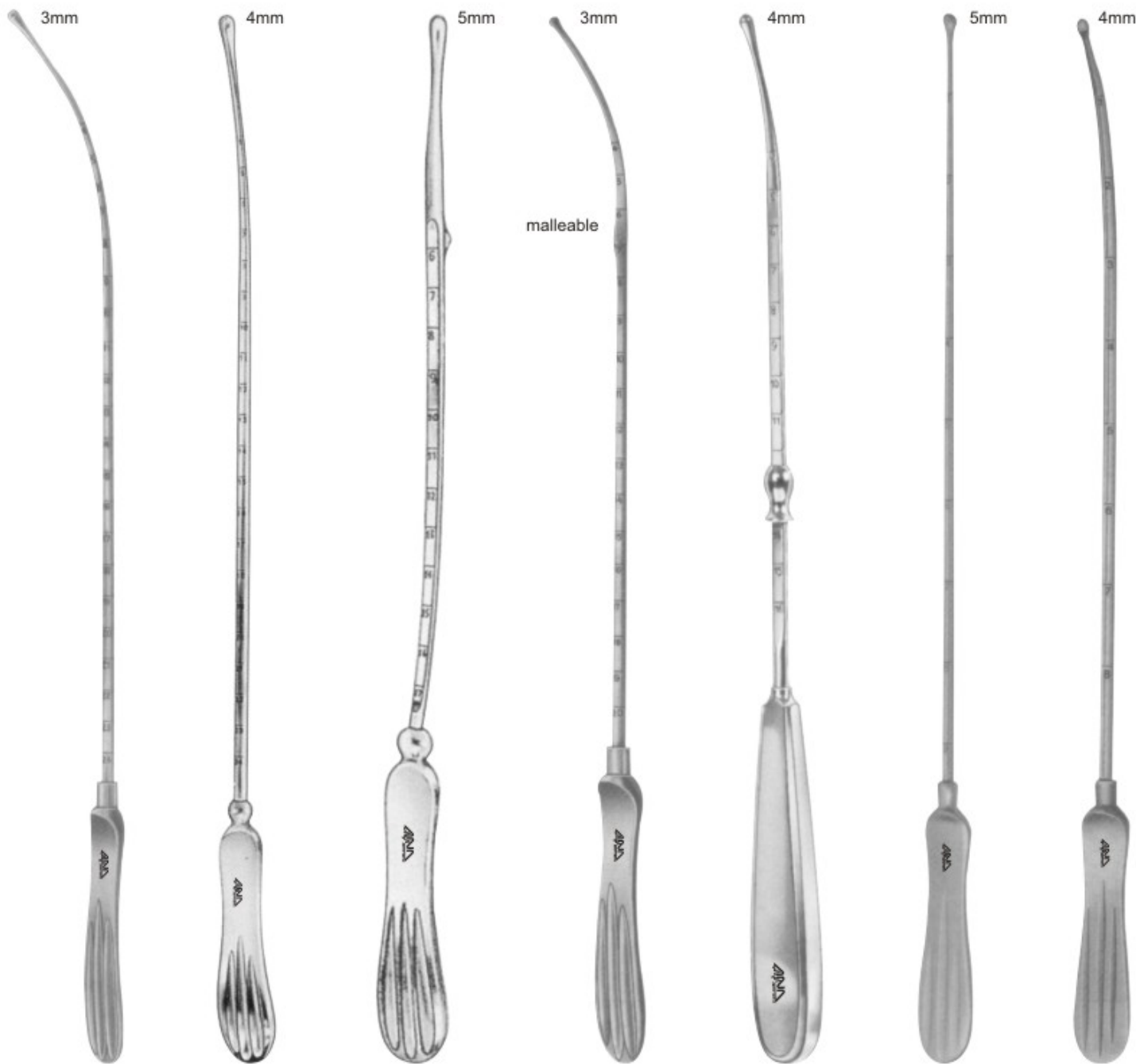

SIMS
ANA-019-466
32 cm, 13"
right
malleable

SIMS-SPECIAL
ANA-019-467
32 cm, 13"

SIMS
schwed. Modell
ANA-019-468
26 cm, 10 1/4"

MARTIN
ANA-019-469
30 cm, 12"

VALLEIX
ANA-019-470
25 cm, 10"

MAYO
ANA-019-471
biegsam
malleable
33 cm

SIMPSON
ANA-019-472
malleable
silver-plated
29 cm

UTERINE SOUNDS



Uterussonden
Histerómetros

Hystéromètres
Isterometri

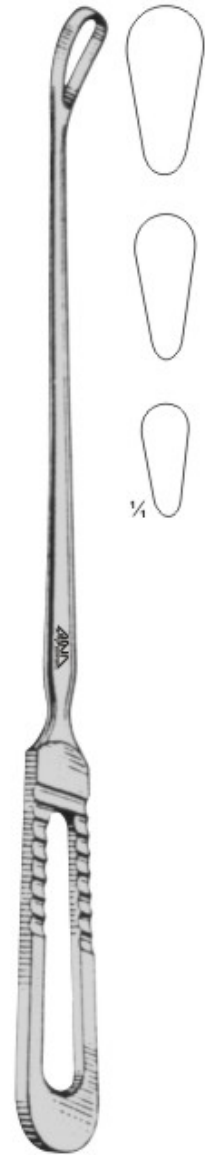
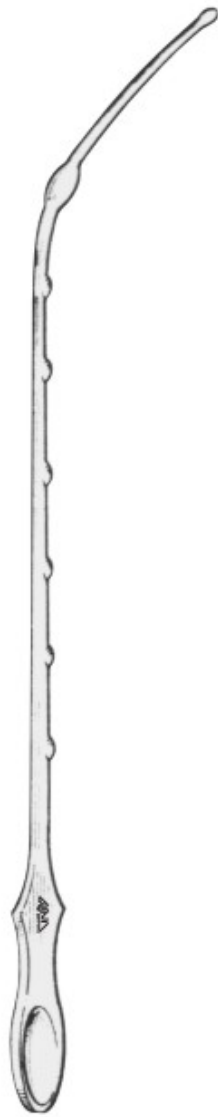
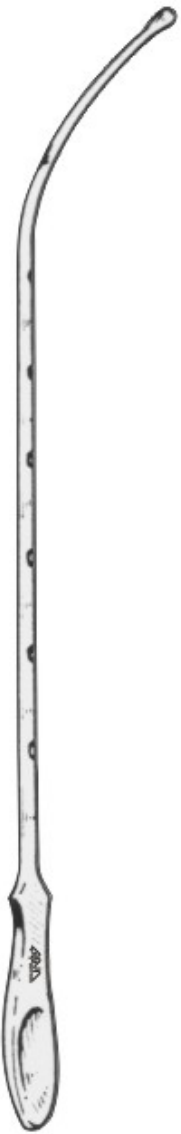

GALABIN
ANA-019-473
malleable, shaft graduated in cm
Silver plated,
32 cm, 12 1/4"

HORROCKS
UTERINE
SOUND
ANA-019-474
malleable, shaft graduated in cm
Silver plated,
32 cm, 12 1/4"

NOVAK "
SUCTION
CANNULA
CURETTE"
ANA-019-475
Luer cone,
25.4 cm, 10"

SIMS UTERINE
CURETTE
ANA-019-476
double ended, sharp
as above but blunt
25 cm, 10"
small, medium, large

SIMS UTERINE
CURETTE.
ANA-019-477
double ended, sharp
25 cm, 10"
long.

SIMS UTERINE
CURETTE
ANA-019-478
single ended, sharp
and blunt ends.
25 cm, 10"
long.

ANA-019-479

suction currettes, stainless steel, fitting hose connection.

Working tips are smoothly rounded of, therefore no danger of perforation.



(Suitable for suction biopsy)

ANA-019-479: diam 4 mm

ANA-019-480: diam 6 mm

ANA-019-481: diam 8 mm

ANA-019-482: diam 10 mm

ANA-019-483: diam 12 mm

ANA-019-484: diam 14 mm

ANA-019-485

Hose connection inside diam. 11 mm curved stainless steel.



ANA-019-486

The new connection between suction curette and hose connection, Guarantees quick changing and free turning of the suction currettes on the hoseconnection

ANA-019-487

Transparent suction hose 1.8 mm long, inside diam 11 mm, outside diam 16.5 mm can be sterilized in an autoclave at 1 bar overpressure (120 C)



ANA-019-488

Strainer for tissue, plastic for single use only, to be used for histopathological examination.

UTERINE FLUSHING TUBE



*Uterussonden
Histerómetros*

*Hystérometres
Isterometri*



BOZEMANN-FRITSCH
ANA-019-489 diam 8 mm
ANA-019-490 diam 10 mm
 Uterine Flushing Tube
 35 cm, 13 3/4"

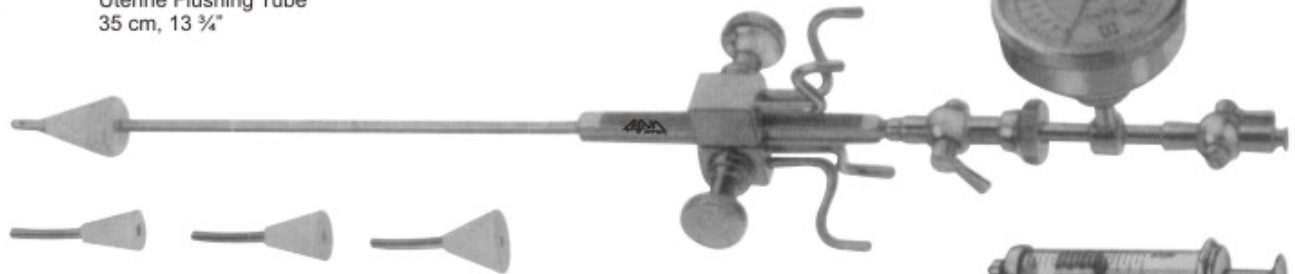

SCHULZE
ANA-019-491

Salpingograph, for utero-salpingography
 in wooden case, consisting of:
 Manometer, Connection, Uterine canulla
 with tap, cone S.M.L,
 record syringe 10 cc, Luer lock mount.



SCHULZE
ANA-019-492

Salpingograph, equipment
 without manometer.

UTERINE DILATORS



Uterusdilatatoren
Dilatadores uterinos

Dilatateurs du col de l'utérus
Dilatatori uterini



PRATT GYNE



PRATT GYNE

ANA-019-493

Set of 8 Double ended
size 13/14 thru 41/43
4.5/5.0mm thru 13.6/14.3mm

ANA-019-494	04.5/05.0 mm
ANA-019-495	05.6/06.3 mm
ANA-019-496	07.0/07.6 mm
ANA-019-497	08.3/09.0 mm
ANA-019-498	09.6/10.3 mm
ANA-019-499	11.0/11.6 mm
ANA-019-500	12.3/13.0 mm
ANA-019-501	13.6/14.3 mm



HEGAR

ANA-019-502

Set of 8 dilator
3/4 mm - 17/18 mm

ANA-019-503

Set of 13 dilator
1/2 mm - 25/26 mm



HANK

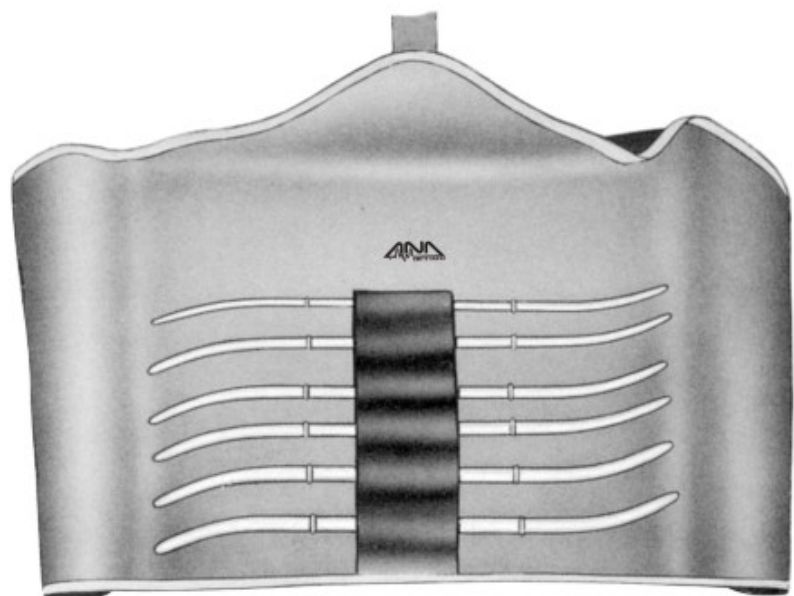

HANK GYNE

ANA-019-510

Set of 6 dilators
4.5/5.0 mm - 9.5/10.0 mm

ANA-019-504	4.5/5 mm
ANA-019-505	5.5/6 mm
ANA-019-506	6.5/7 mm
ANA-019-507	7.5/8 mm
ANA-019-508	8.5/9 mm
ANA-019-509	9.5/10 mm

UTERINE DILATORS



Uterusdilatoren
Dilatadores uterinos

Dilatateurs du col de l'utérus
Dilatatori uterini



ANA-019-511
Set of 13 dilators
1/2 mm - 25/26 mm
ANA-019-512
Set of 8 dilators
3/4 mm - 17/18 mm

HEGAR GYNE



HEGAR GYNE
ANA-019-525
Set of 8 dilators
3/4 mm - 17/18 mm



ANA-019-526	1 mm
ANA-019-527	2 mm
ANA-019-528	3 mm
ANA-019-529	4 mm
ANA-019-530	5 mm
ANA-019-531	6 mm
ANA-019-532	7 mm
ANA-019-533	8 mm
ANA-019-534	9 mm
ANA-019-535	10 mm
ANA-019-536	11 mm
ANA-019-537	12 mm
ANA-019-538	13 mm
ANA-019-539	14 mm
ANA-019-540	15 mm
ANA-019-541	16 mm
ANA-019-542	17 mm
ANA-019-543	18 mm
ANA-019-544	19 mm
ANA-019-545	20 mm
ANA-019-546	21 mm
ANA-019-547	22 mm
ANA-019-548	23 mm
ANA-019-549	24 mm
ANA-019-550	25 mm
ANA-019-551	26 mm
ANA-019-552	27 mm
ANA-019-553	28 mm
ANA-019-554	29 mm
ANA-019-555	30 mm

HEGAR GYNE
ANA-019-526
Set of 26 dilators
1 mm - 26 mm

ANA-019-556
Set of 14 dilators
4 mm - 17 mm

ANA-019-557	1.5 mm
ANA-019-558	2.5 mm
ANA-019-559	3.5 mm
ANA-019-560	4.5 mm
ANA-019-561	5.5 mm
ANA-019-562	6.5 mm
ANA-019-563	7.5 mm
ANA-019-564	8.5 mm
ANA-019-565	9.5 mm
ANA-019-566	10.5 mm
ANA-019-567	11.5 mm
ANA-019-568	12.5 mm
ANA-019-569	13.5 mm
ANA-019-570	14.5 mm
ANA-019-571	15.5 mm
ANA-019-572	16.5 mm
ANA-019-573	17.5 mm
ANA-019-574	18.5 mm
ANA-019-575	19.5 mm



HEGAR GYNE
ANA-019-576
Set of 14 dilators
4 mm - 17 mm

UTERINE BIOPSY FORCEPS

Probeexzisionszangen
Pinzas para biopsia

Pinces pour biopsi
Pinze per biopsia



TISCHLER-KEVORKIAN
ANA-019-577
22 cm, 8 3/4"
with latch
3 x 9.5 mm

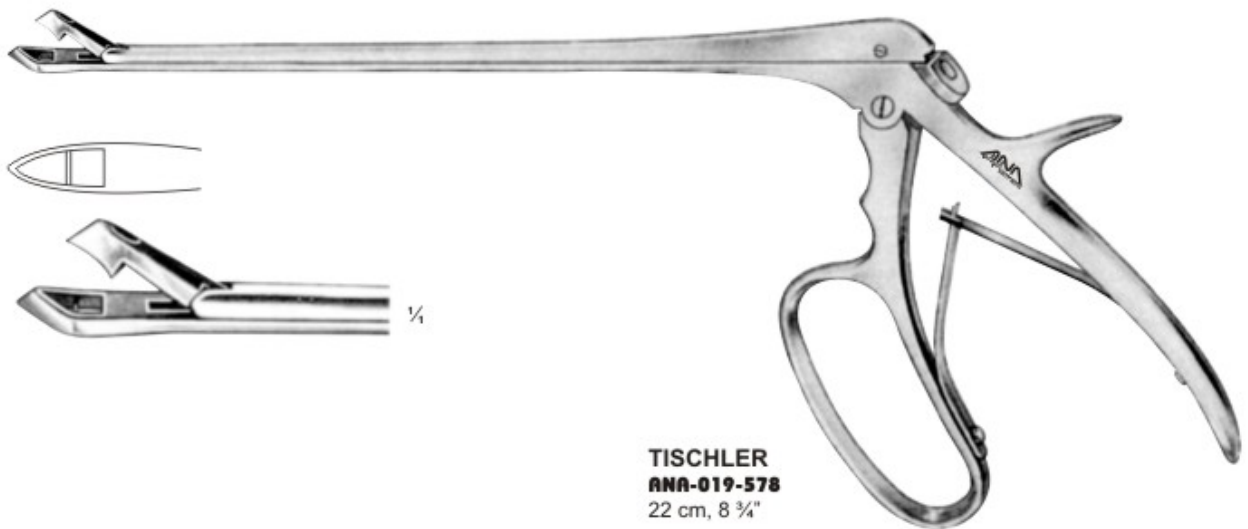

TISCHLER
ANA-019-578
22 cm, 8 3/4"

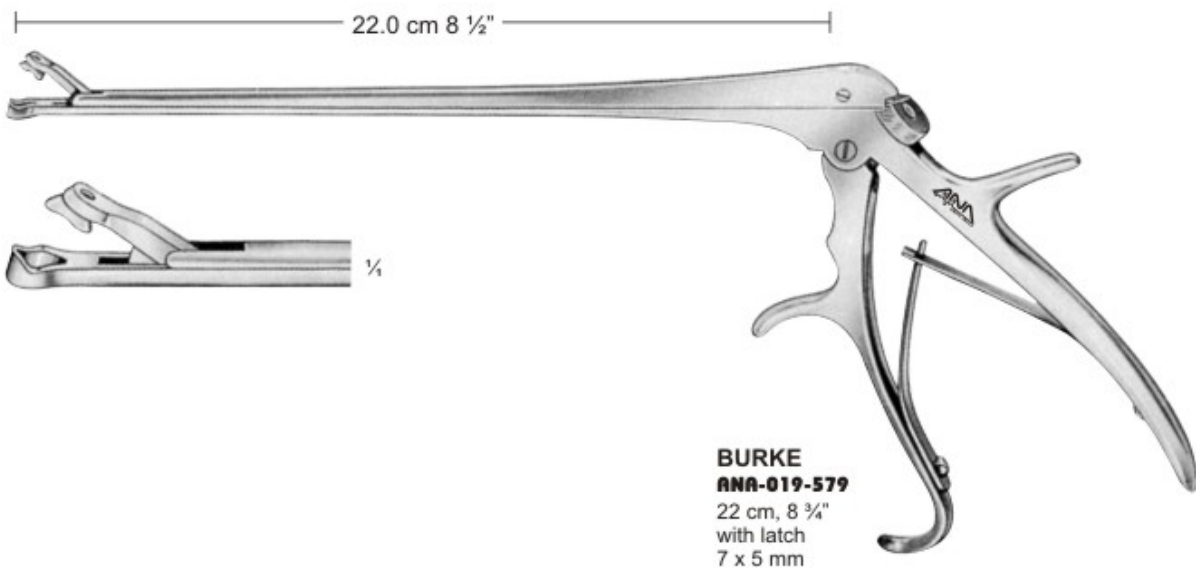

BURKE
ANA-019-579
22 cm, 8 3/4"
with latch
7 x 5 mm

UTERINE BIOPSY FORCEPS



Probeexzisionszangen
Pinzas para biopsia

Pinces pour biopsi
Pinze per biopsia

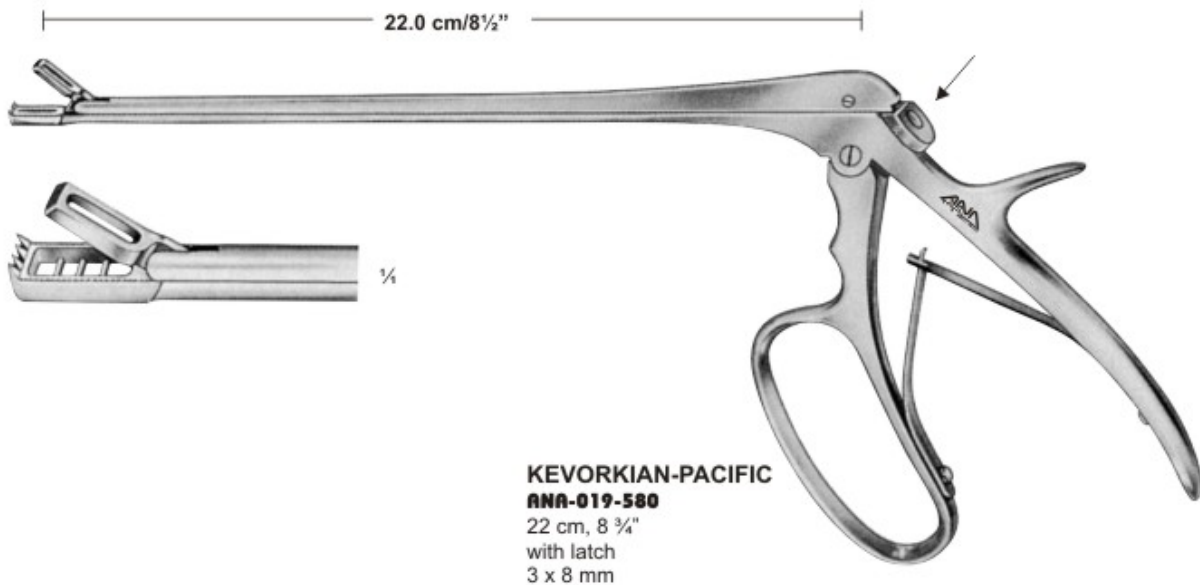

KEVORKIAN-PACIFIC
ANA-019-580
22 cm, 8 3/4"
with latch
3 x 8 mm



ALEXANDER
ANA-019-581
20 cm, 8"

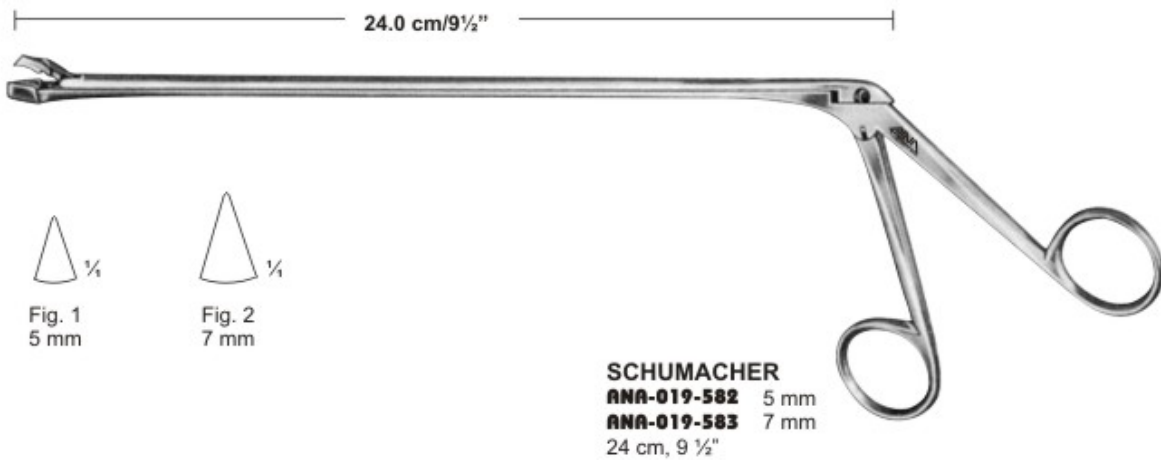

SCHUMACHER
ANA-019-582 5 mm
ANA-019-583 7 mm
24 cm, 9 1/2"

UTERINE BIOPSY FORCEPS



Probeexzisionszangen
Pinzas para biopsia

Pinces pour biopsi
Pinze per biopsia

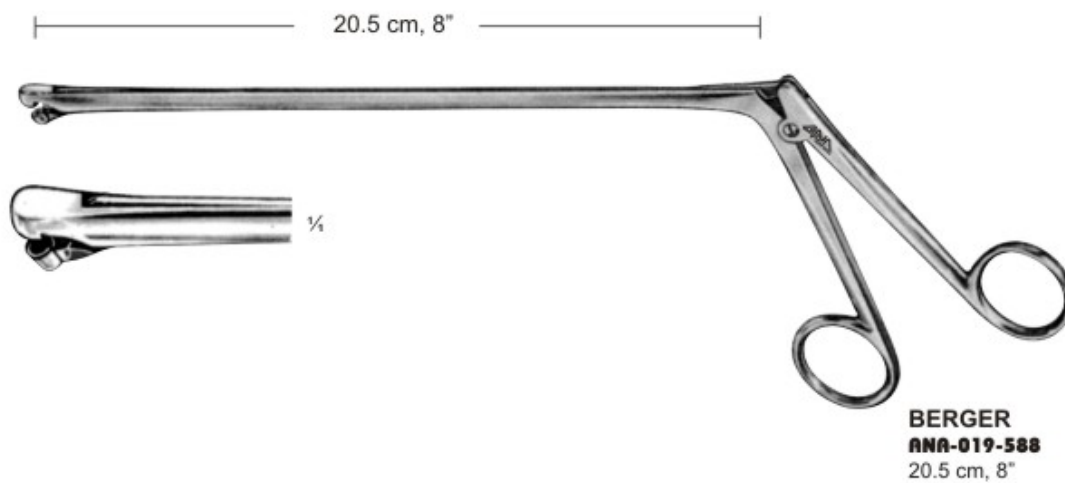
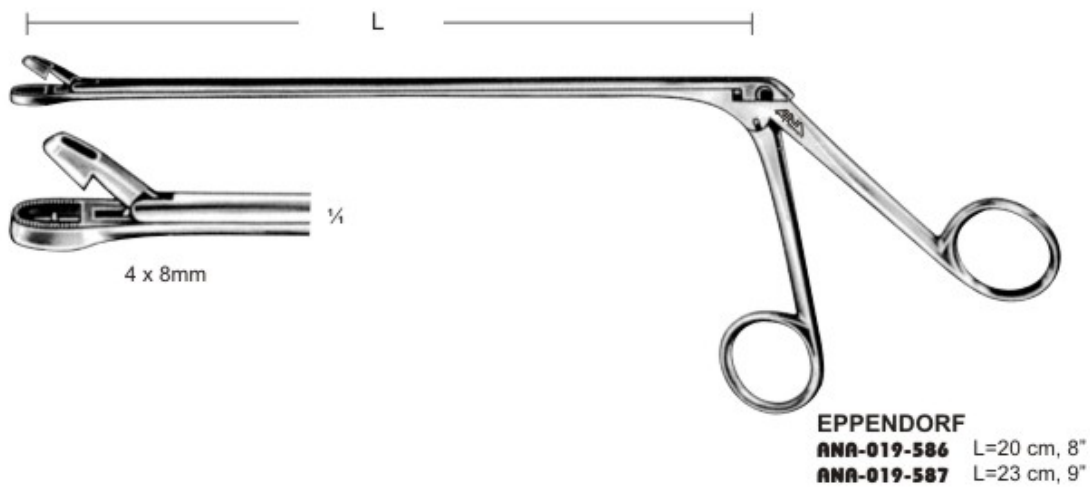
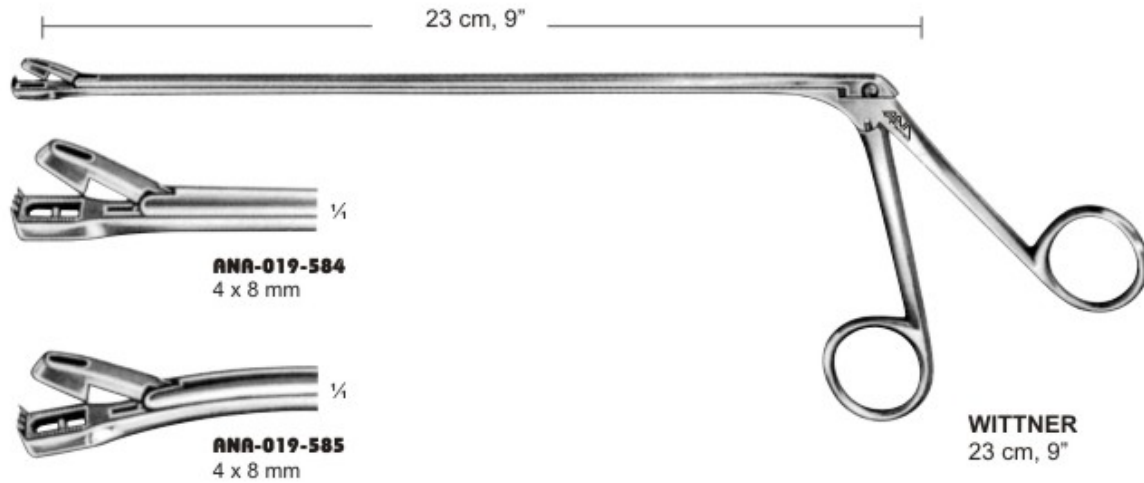

UTERINE BIOPSY FORCEPS



Probeexzisionszangen
Pinzas para biopsia

Pinces pour biopsi
Pinze per biopsia

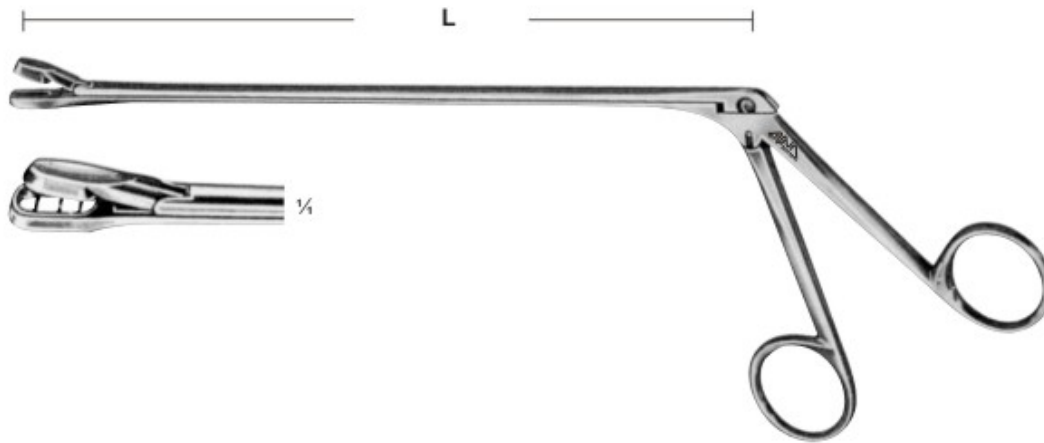

DOUAY

- ANA-019-589** L=20 cm, 8"
- ANA-019-590** L=25 cm, 10"
- ANA-019-591** L=30 cm, 12"
- ANA-019-592** L=35 cm, 14"
- ANA-019-593** L=40 cm, 16"

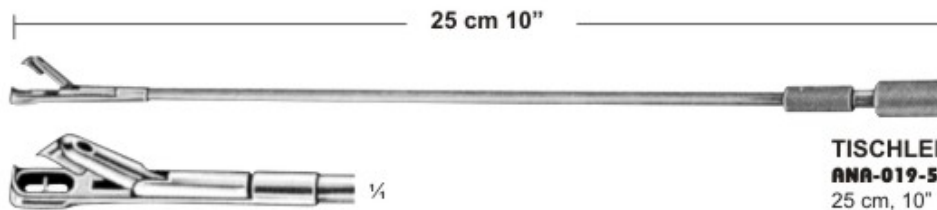

TISCHLER
ANA-019-595
25 cm, 10"

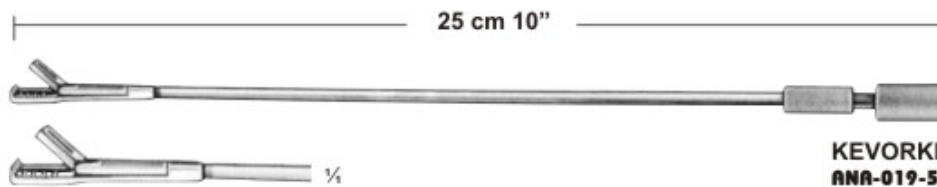

KEVORKIAN
ANA-019-596
25 cm, 10"

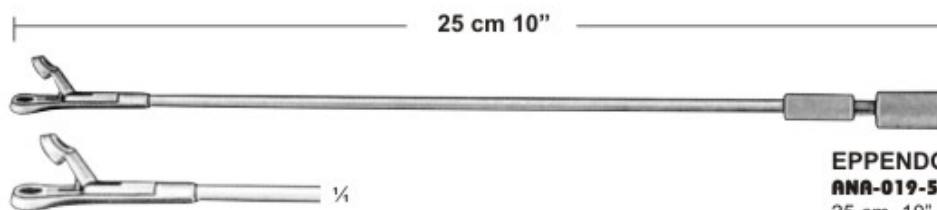

EPPENDORF
ANA-019-597
25 cm, 10"

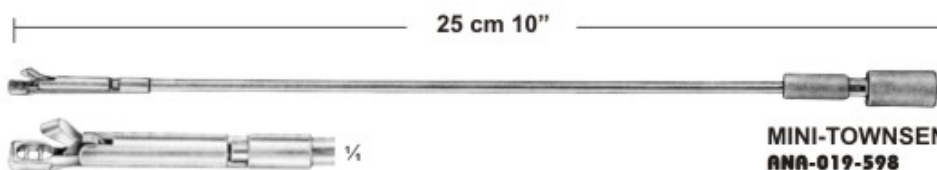

MINI-TOWNSEND
ANA-019-598
25 cm, 10"



ANA-019-594

UTERINE BIOPSY FORCEPS



Probeexzisionszangen
Pinzas para biopsia

Pinces pour biopsi
Pinze per biopsia

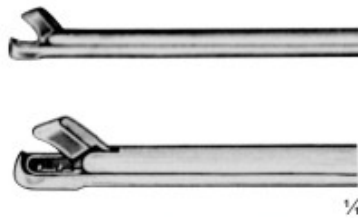

ANA-019-599
20 cm, 8"
With Fixing Screw
2.3 x 4.2 mm
ANA-019-600
20 cm, 8"
Without Fixing Screw
2.3 x 4.2 mm



TISCHLER

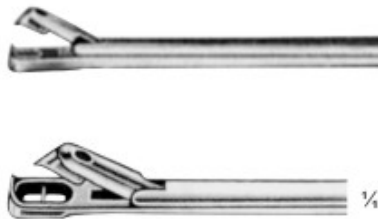

ANA-019-601
22 cm, 8 3/4"
3 x 7 mm



TISCHLER-MORGAN

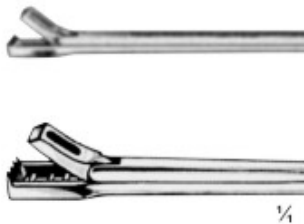

ANA-019-602
23 cm, 9"
3 x 9.7 mm
ANA-019-603
25 cm, 10"
3 x 9.7 mm



KEVORKIAN

UTERINE BIOPSY FORCEPS



Probeexzisionszangen
Pinzas para biopsia

Pinces pour biopsi
Pinze per biopsia



GELLHORN
ANA-019-604
23 cm, 9"



FAURE
ANA-019-605
23 cm, 9"



SCHUBERT
ANA-019-606 21 cm, 8 1/4"
ANA-019-607 28 cm, 11"



THOMS-GAYLOR
ANA-019-608
24 cm, 9 1/2"



SCHUBERT
ANA-019-609
26 cm, 10 1/4"

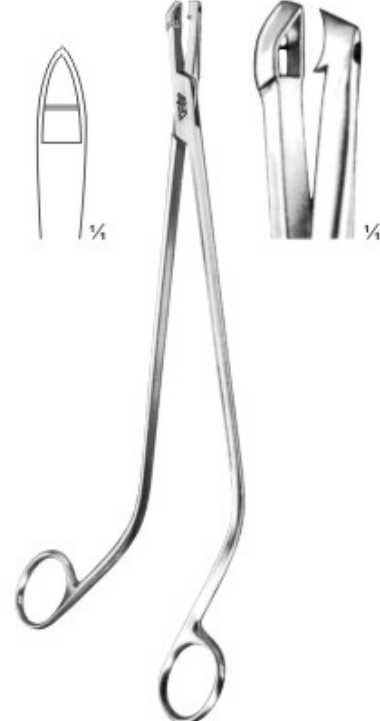

TISCHLER
ANA-019-610
27 cm, 10 1/2"

UTERINE BIOPSY FORCEPS



Probeexzisionszangen
Pinzas para biopsia

Pinces pour biopsi
Pinze per biopsia

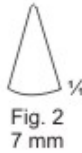
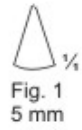

SCHUMACHER-NAN-DOREN
ANA-019-611 Fig. 1
ANA-019-612 Fig. 2
24 cm, 9 1/2"



VAN DOREN
ANA-019-613
25 cm, 10"



VAN DOREN
ANA-019-614
25 cm, 10"



NAEGELE
ANA-019-615
25 cm, 10"



SPELLIE
ANA-019-616
25 cm, 10"



BRAUN
ANA-019-617
30 cm, 12"



SPELLIE
ANA-019-618
30 cm, 12"

PLACENTA & OVUM FORCEPS

Abortuszangen
Pinzas para aborto

Pinces placentaires et pour poste-abortum
Pinze per placenta e per ovaie

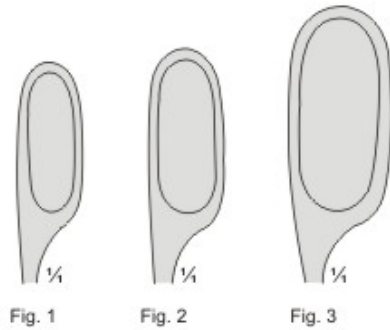

WINTER
ANA-019-619 Fig. 1
ANA-019-620 Fig. 2
ANA-019-621 Fig. 3
28 cm, 11"



WINTER
ANA-019-622 Fig. 1
ANA-019-623 Fig. 2
ANA-019-624 Fig. 3
28 cm, 11"

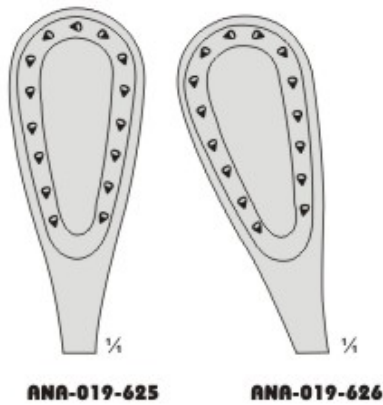

SAENGER
27 cm, 10 1/2"

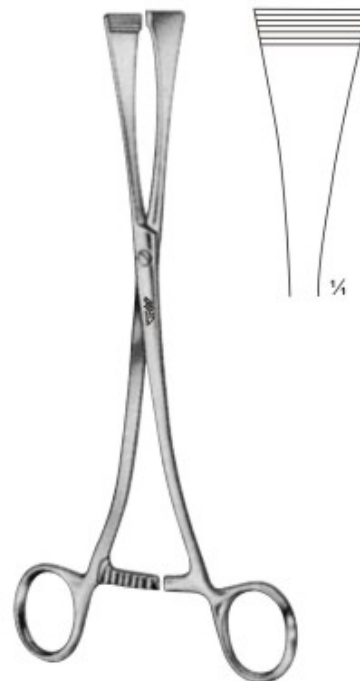

GREEN-ARMYTAGE
ANA-019-627
21 cm, 8 1/4"



WALLICH
ANA-019-628
42 cm, 16 1/2"

OBSTETRICAL FORCEPS



Geburtszangen
Forceps obstétricos

Forceps obstétriques
Forcipi obstetrici

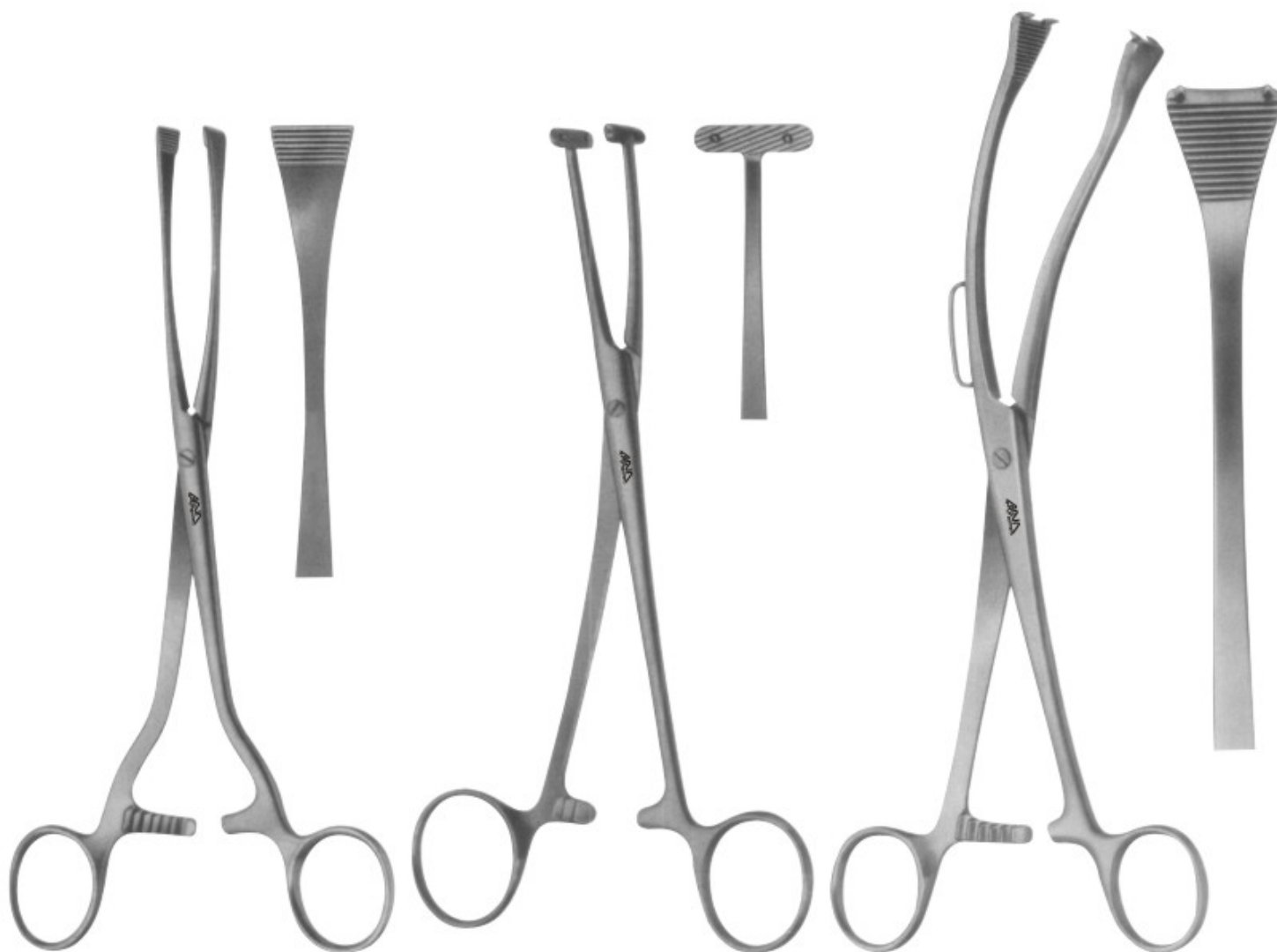

GREEN-ARMYTAGE
ANA-019-629

caesarean section haemostatic
forceps, for edges of the transverse
incision in the lower segment
22 cm, 8 3/4"

WILLETT
ANA-019-630

Scalpel Flap Forceps
18.5 cm, 7 1/4"

GAUSS
ANA-019-631

Scalpel Flap Forceps
26 cm, 10 1/4"

PELVIMETER, OBSTETRICAL FORCEPS



Beckenzirkel, Geburtszangen
Pelvímetro, Forceps obstétricos

Pelvimètre, Forceps obstétriques
Pelvimetri, Forcipi obstetrici



THOLE
ANA-019-632
for internal and external measurements, graduated in centimeters



DE LEE
ANA-019-633
graduated in centimeters and inches



COLLIN
ANA-019-634
graduated in centimeters



MARTIN
ANA-019-635
graduated in centimeters



for internal measurements between symphysis and promontory

COLLIN
ANA-019-636
graduated in centimeters



The additional straight arm can be replaced. The pelvimeter with straight arm is used for localisation of the portio vaginalis uteri and of vaginal metastasis.



BREISKY
ANA-019-637
graduated in centimeters

OBSTETRICAL FORCEPS



Geburtszangen
Forceps obstétricos

Forceps obstétriques
Forcipi obstetrici



PIPER
ANA-019-638
44 cm, 18"



NAEGELE
ANA-019-639 36 cm, 14 1/4"
ANA-019-640 40 cm, 15 3/4"



SIMPSON
ANA-019-641
30 cm, 12"



SIMPSON-BRAUN
ANA-019-642 33 cm, 13 1/2"
ANA-019-643 38 cm, 14 1/2"



MCLEAN
ANA-019-644
36 cm, 14 1/4"



KIELLAND
ANA-019-645
41 cm, 16"

OBSTETRICAL FORCEPS



Geburtszangen
Forceps obstétricos

Forceps obstétriques
Forcipi obstetrici



KIELLAND-LUIKART
ANA-019-646
41 cm, 16"



WRIGLEY
ANA-019-647
23 cm, 9"



DE LEE
ANA-019-648
30 cm, 12"

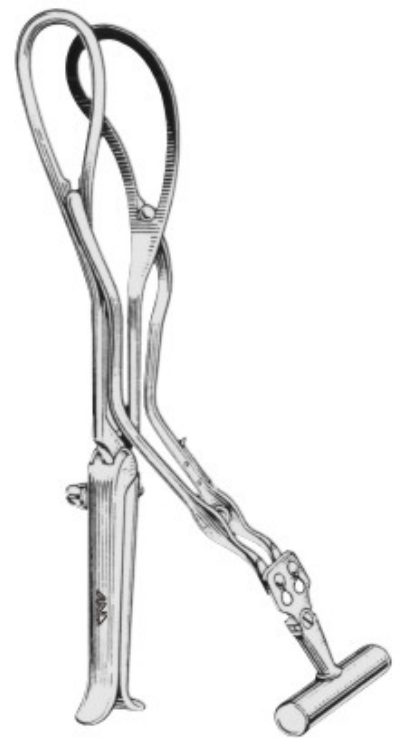

MILNE MURRAY
ANA-019-649
detachable axis traction
rod & handle.

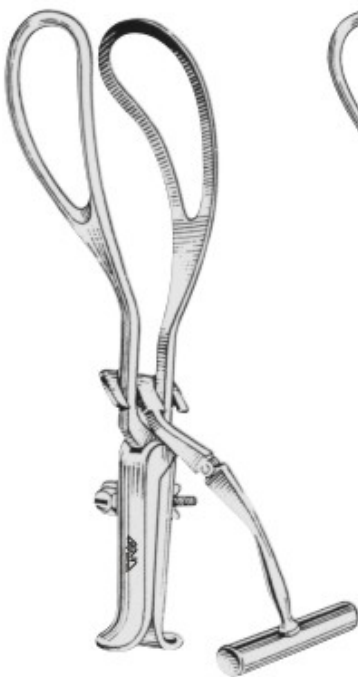

HAIG FERGUSON
ANA-019-650
detachable axis traction
rod & handle.



BARNES-NEVILLE
ANA-019-651
Simpson handles, detachable
axis traction rod and handle.



BRAUN
ANA-019-652
42 cm, 16 1/4"



TARNIER
ANA-019-653
44 cm, 17 1/4"